

N13 040 050

Floor plan

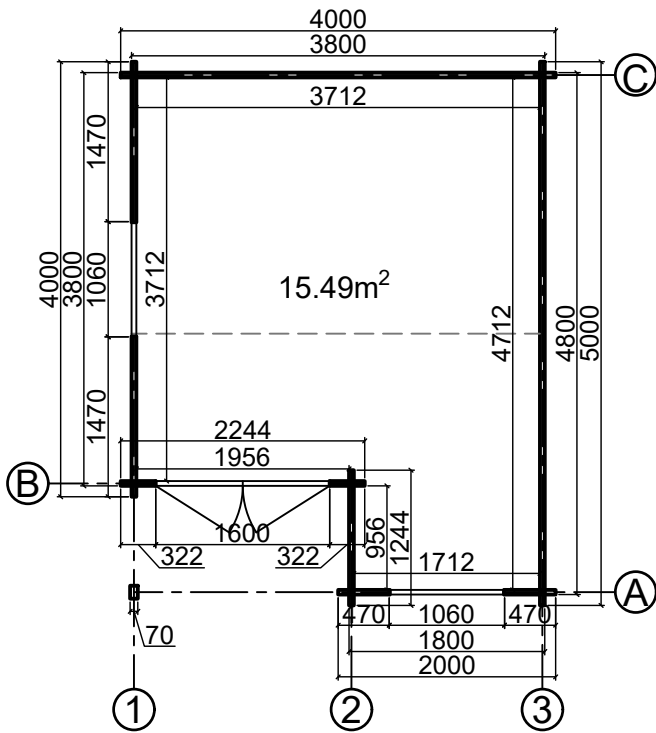

Base plan

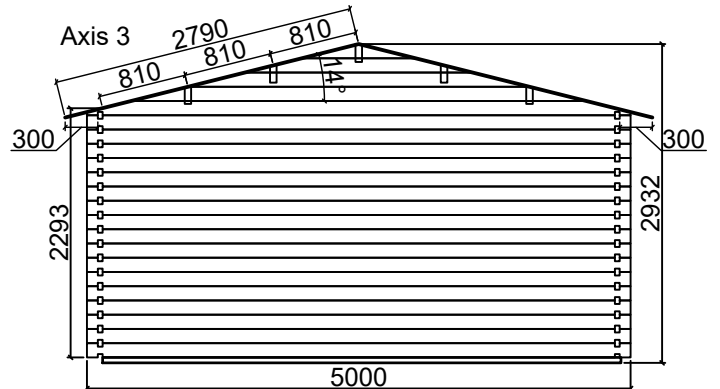
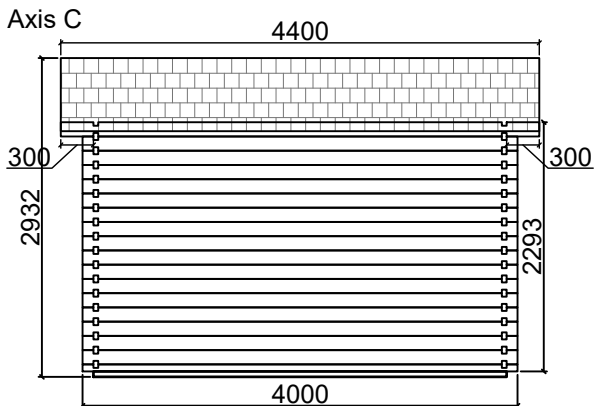
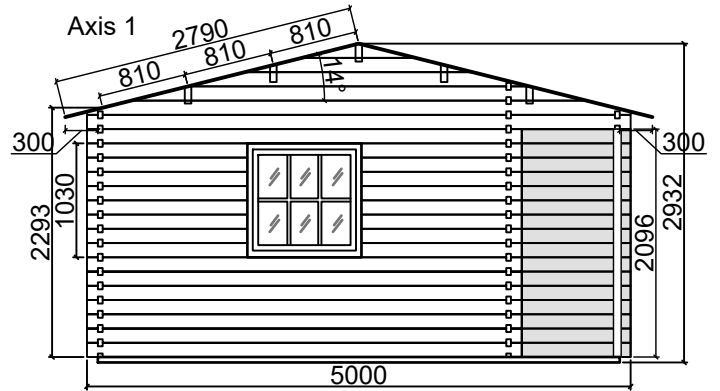
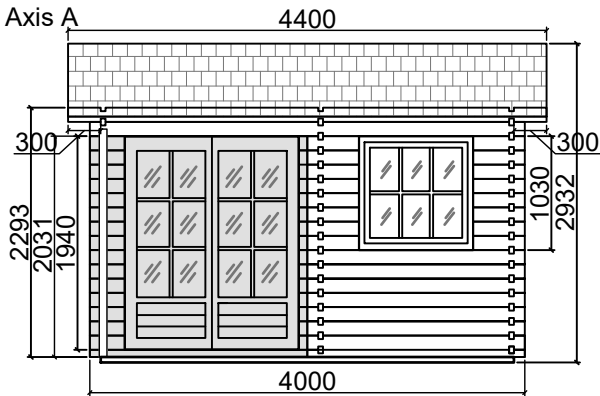
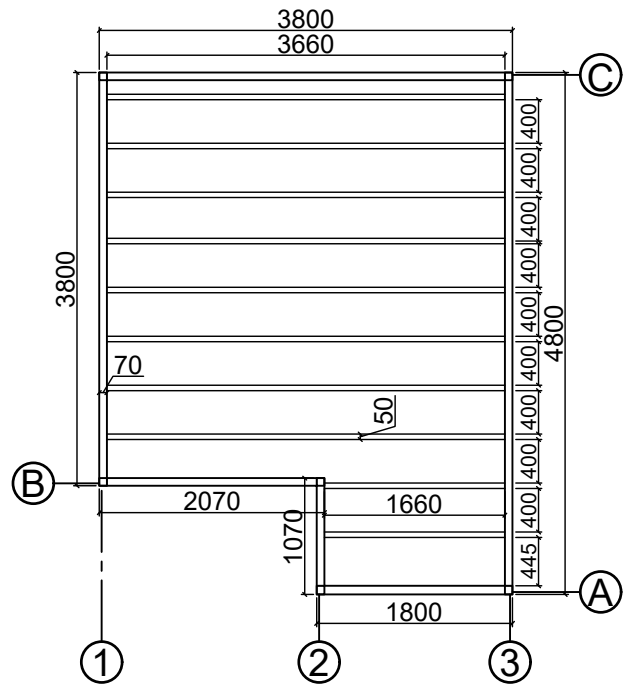

CODE	P3	W2
SIZE/mm	1600x1940	1060x1030
QUANTITY	1	2
LEFT/RIGHT	0/1	0/2

CABIN SPECIFICATION

WALL LOG:	44mm
SIZE (m):	4x5
SIDE WALL HEIGHT :	2293 mm
RIDGE HEIGHT:	2932 mm
FLOOR AREA m ² :	15.49
ROOF AREA m ² :	24.55
FLOOR BOARDS mm:	19