

Floor plan

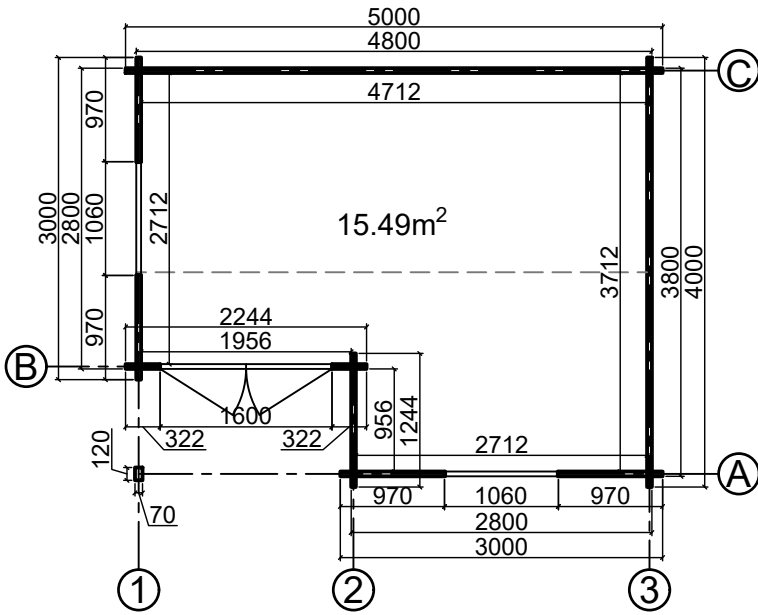

Base plan

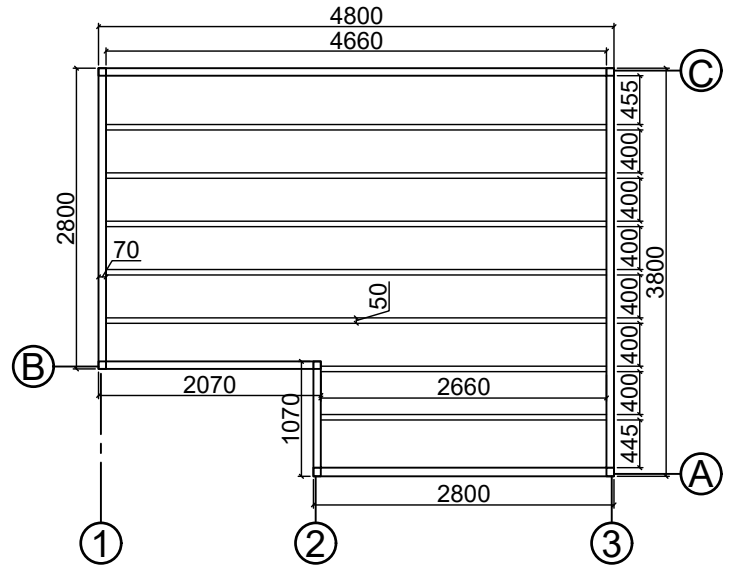

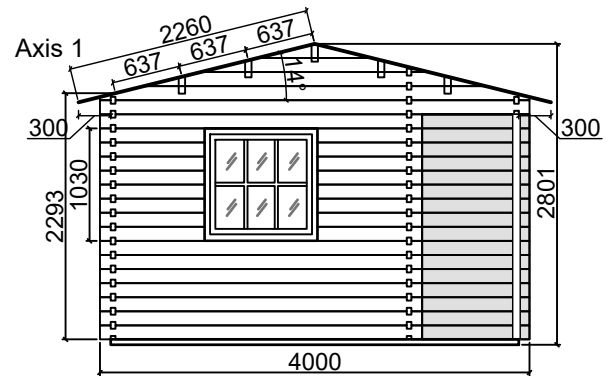
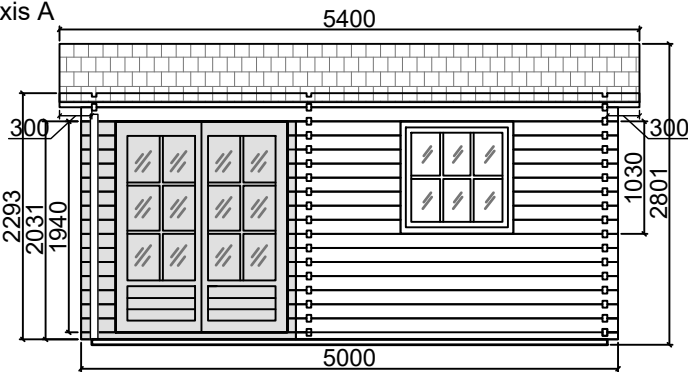

Axis A

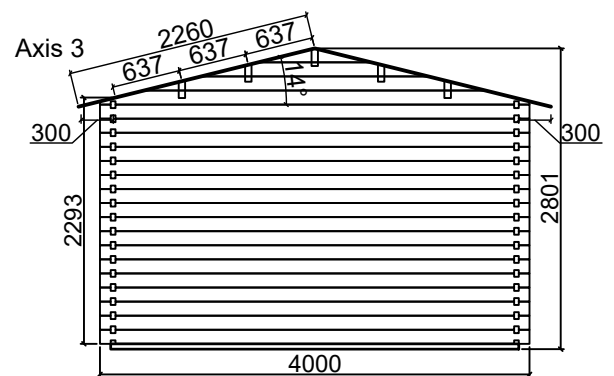
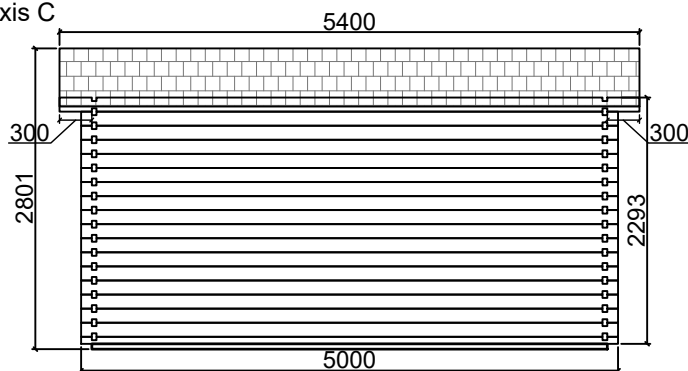

Axis C



		
CODE	P3	W2
SIZE/mm	1600x1940	1060x1030
QUANTITY	1	2
LEFT/RIGHT	0/1	0/2

CABIN SPECIFICATION

WALL LOG:	44mm
SIZE (m):	5x4
SIDE WALL HEIGHT :	2293 mm
RIDGE HEIGHT:	2801 mm
FLOOR AREA m ² :	15.49
ROOF AREA m ² :	24.4
FLOOR BOARDS mm:	19