

Floor plan

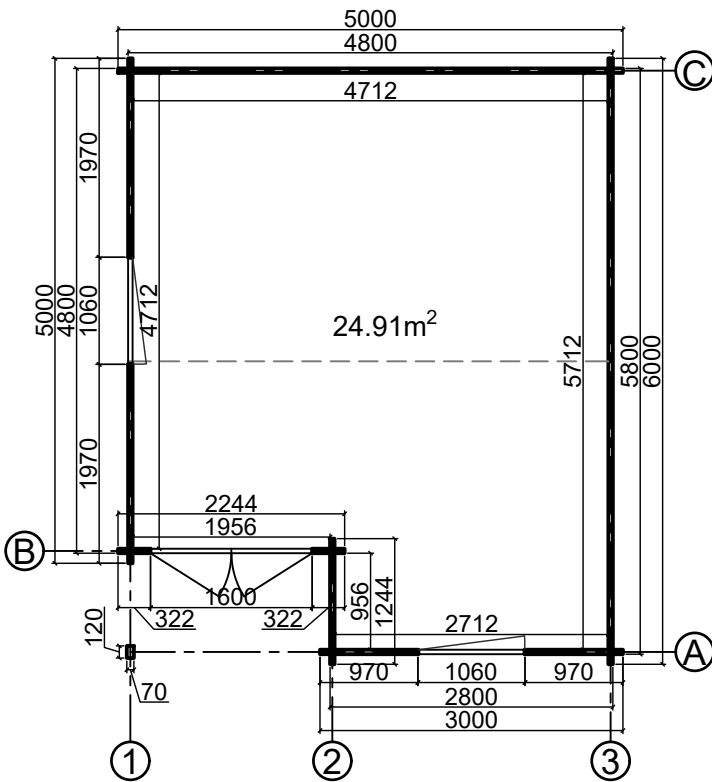

Base plan

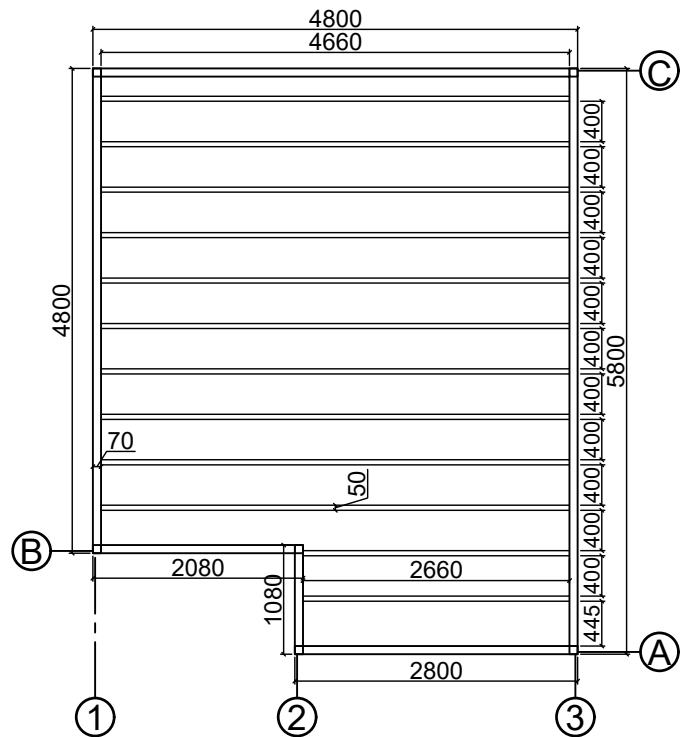

Axis A

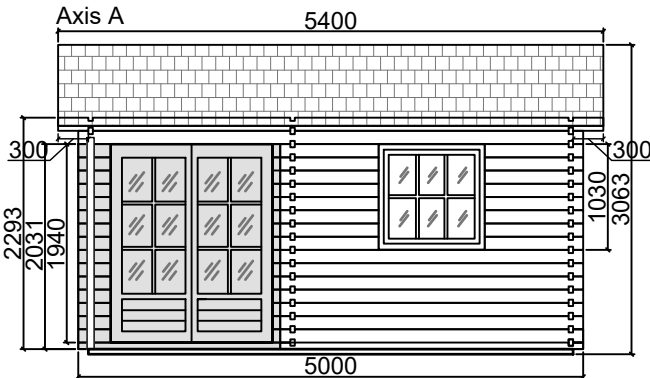

Axis 1

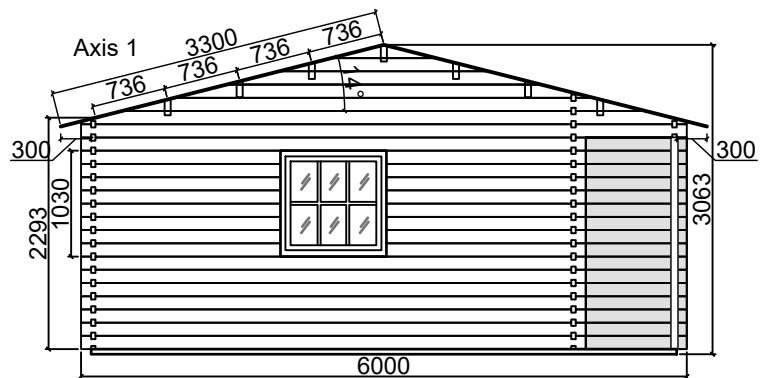

Axis C

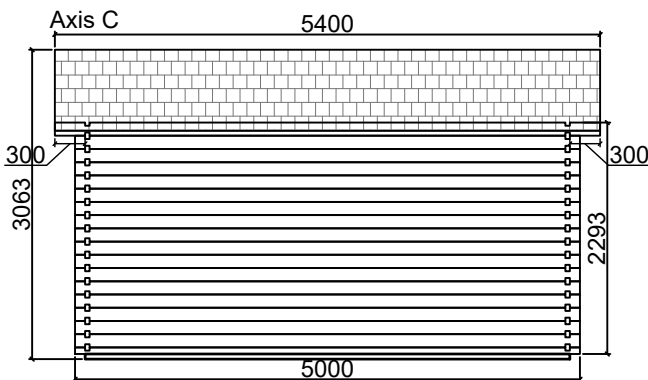

Axis 3

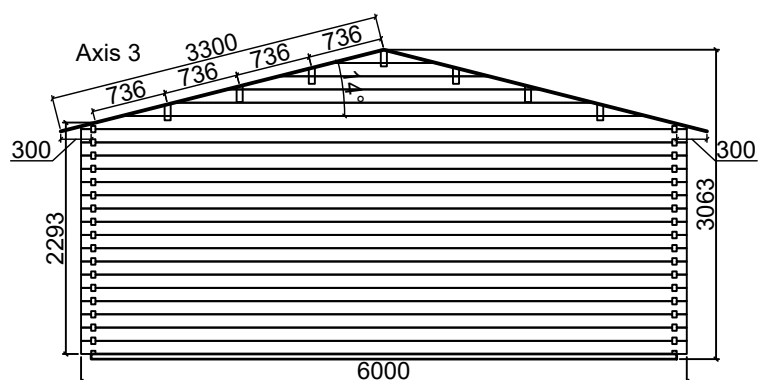

CODE	<b>P3</b>	<b>W2</b>
SIZE/mm	1600x1940	1060x1030
QUANTITY	<b>1</b>	<b>2</b>
LEFT/RIGHT	<b>0/1</b>	<b>0/2</b>

### CABIN SPECIFICATION

WALL LOG:	44mm
SIZE (m):	5x6
SIDE WALL HEIGHT :	2293 mm
RIDGE HEIGHT:	3063 mm
FLOOR AREA m <sup>2</sup> :	24.91
ROOF AREA m <sup>2</sup> :	35.64
FLOOR BOARDS mm:	19