

Floor plan

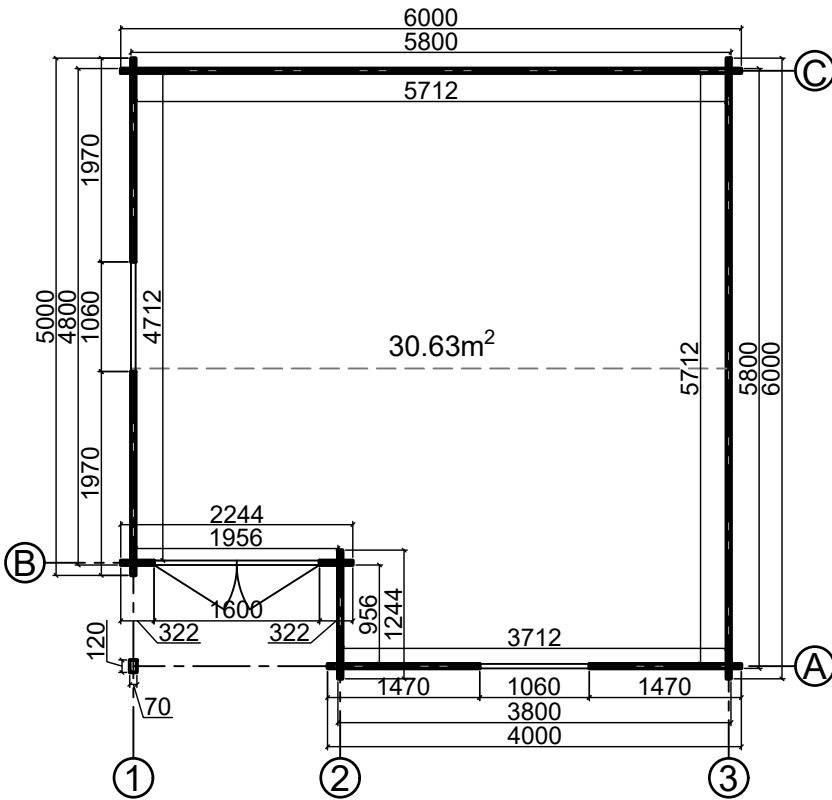

Base plan

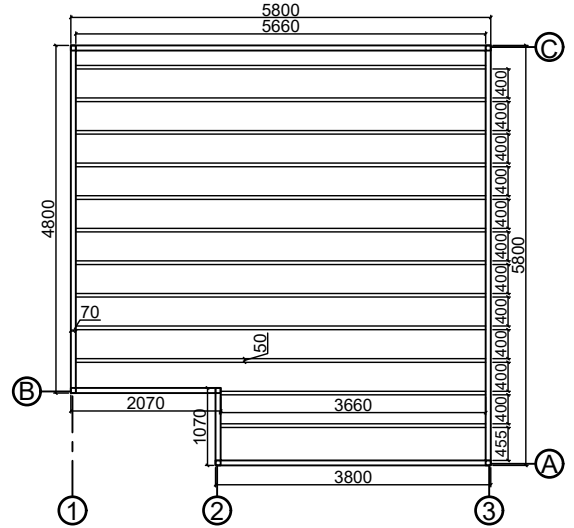

Axis A

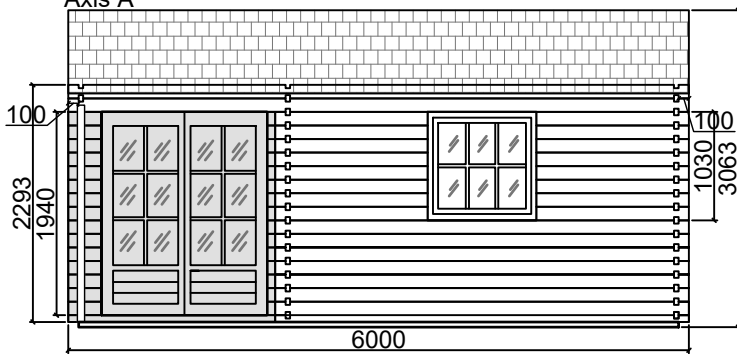

Axis 1

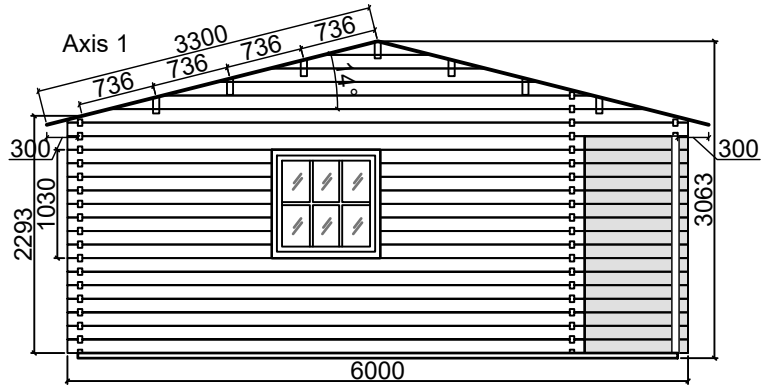

Axis C

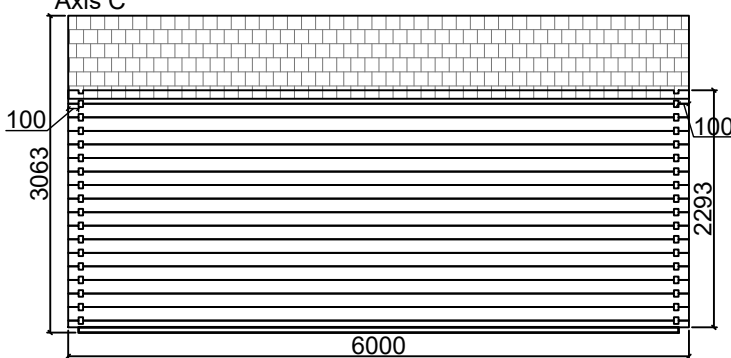

Axis 3

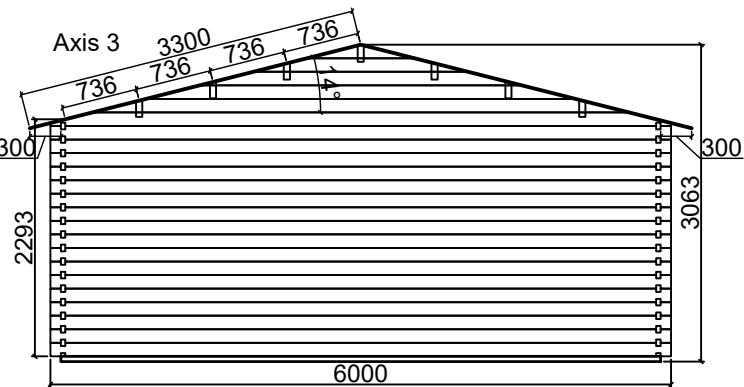

CODE	P3	W2
SIZE/mm	1600x1940	1060x1030
QUANTITY	1	2
LEFT/RIGHT	0/1	0/2

CABIN SPECIFICATION

WALL LOG:	44mm
SIZE (m):	6x6
SIDE WALL HEIGHT :	2293 mm
RIDGE HEIGHT:	3063 mm
FLOOR AREA m ² :	30.63
ROOF AREA m ² :	39.6
FLOOR BOARDS mm:	19